

Nothing Can Be Sold At Any Price Unless The People Know It Is For Sale

VOLUME 13

PUTNAM, CALLAHAN COUNTY, TEXAS

Thursday, March 3, 1949

NUMBER 4

From The Editor's Window

BY MRS. J. S. YEAGER

The Pocket Testament League of New York City has announced that General Douglas MacArthur has accepted the League offer to distribute in Japan one million copies of the Gospels and New Testaments, printed in the Japanese language.

More than 3,000 cases of measles were reported in Texas last week — the largest number ever reported for one week in this state — the Department of Health has announced.

It is said that in 1870 there were four persons for every cow in the United States. Today we have nearly six persons for every cow, but our people are getting about as much milk as they ever did.

An exchange tells of a 30-year-old man who claims he has never shaved in his life and has only seen two movies. He soliloquized — "Spending ten minutes a day shaving is a waste of time; it is much easier to let your whiskers grow."

Barber — "Shall I cut your hair close?"

Customer — No, I'd rather you stand off a little distance.

"Why is it that Willie chooses a musical instrument when we ask him what he wants, every time?" asked father.

"That's easily explained," replied mother, "our next door neighbor is always willing to pay him not to play it. That is one way Willie makes his spending money."

Freedom can live in a world where man is regarded as a child of God and, therefore, as a creature of dignity and worth.

It cannot live in a world where God is denied and where in consequence of this denial, human beings have come to be regarded as mere pawns in the game of power politics. — Rev. Ernest Fremont.

Rice, basic diet for millions of people, is an annual grass. Most of it is grown standing in water, but some species are said to be successfully grown on ordinary land.

Dennis Day, in a discussion of income and budgets, quipped — "A man isn't kept poor by the wolf at the door, but by the silver fox in the window."

An exchange says, "When a fellow is down, there is only one way, then, for him to go and that is upward."

Mr. and Mrs. Robert Williams of Abilene and Mr. and Mrs. Hubert Buchanan of Lubbock were weekend visitors in the home of Mrs. Williams and Mr. Buchanan's parents, Mr. and Mrs. W. A. Buchanan. Mr. and Mrs. Buchanan returned to Lubbock to visit with Mr. and Mrs. H. H. Buchanan.

Livestock Show Ranger Mar. 18-19

The Tri-County Livestock Show, sponsored by the Ranger Junior Chamber of Commerce is to be held in Ranger March 18 and 19.

This show will include classes for beef cattle, dairy cattle, sheep, horses, and poultry, and every showman in Eastland, Stephens and Palo Pinto counties is invited to exhibit his stock.

Five hundred dollars in premiums will be awarded in the Junior division and ribbons will be given to winners in the adult classes. One of the outstanding features of this year's show is a "Scramble Class" for the steers that were caught last summer in the Jaycees annual rodeo calves.

Miss Guinn Dickey Honored With Party

A gift party was given honoring Miss Guinn Dickey, bride elect of Will Young of Abilene, recently in the home of Mrs. Colonel Dyer of Baird. Receiving the guests were Ruth Dyer the bride elect, her mother, Mrs. N. L. Dickey, and her granddaughter, Mrs. J. W. Brown. The guests were registered by Mrs. James Morgan. Ruth Dyer showed gifts and Miss Evelyn Frazier ushered the guests into the dining room where they were served by Mrs. Bill Alexander and Mrs. Colonel Dyer.

The table was laid with a linen cutwork tablecloth with appointments of silver. The centerpiece was an arrangement of white gladioli flanked by white candles.

Hostesses of the party were Mrs. Earnest Windon, Mrs. Richard Windom, Mrs. Colonel Dyer, Mrs. Carl Yarbrough, Mrs. James Morgan, Mrs. Bill Alexander, Evelyn Frazier, Ruth Dyer and Madge Loper.

State Leases Land For Hundred Years

AUSTIN, March 3. — Land Commissioner, Bascom Giles has found a 'steady customer' for a small tract of school land in Pecos County.

The Commissioner has received payment from an oil company covering rental on the tract years, making the present lease effective until the year 2049.

The tract, less than two acres in size, is one of the smallest in the School Land Board's records. However, it has paid off in man-sized hunks — \$20,000.00 to the Permanent School Fund in cash bonuses and \$217,398.00 in royalties.

The 100-year rental payment is without precedent, Giles stated.

However, added the Commissioner, the lease may be forfeited unless production is maintained and unless all regulations of the School Land Board are conformed with.

Cotton Dusted Shows Increase In Production

Call to cotton farmers—Don't forget your poison material this year. From all indications of cotton planted this year for there will be a large acreage of cotton planted this year. For Thrips, aphids, flea hoppers or boll weavils alone or in combinations is the 3-5-40 mixtures. This is 3% gamma benzene hexachloride, 5% sulphur. 20% chlorinated camphens with 40% sulphur is also a good dust. Early season dusting is a good investment to where flea hoppers, aphids and insure early fruiting in areas boll weavils and thrips do damage. The first dusting should be made soon after the cotton has been chopped and plowed and the last dusting of the Early Season Control Program should be made before the crop starts blooming. Poison cotton after the bloom appears should be followed with caution.

Tests that were made by the Texas Agricultural Experiment Station during 1944 and in 1947 showed that cotton dusted with the 3-5-40 made on an average of 511 pounds of seed cotton per acre more than untreated cotton.

14 State's Counties Get Awards For Top 4-H Recreation Clubs

Fourteen Texas counties naming a blue award group of clubs in the 1948 National 4-H Recreation and Rural Art awards program have each received \$2,000 for the purchase of recreation equipment, the National Committee on Boys and Girls Club Work has announced.

Counties receiving awards were: Bastrop, Bexar, Castro, Dallas, Frio, Guadalupe, Somervell, Nacogdoches, Calhoun, Atascosa, Tom Green, Parker, Terry and Cooke. All awards are provided by the United States Rubber Company. The program is conducted under the supervision of the Cooperative Extension Service.

Purpose of the recreation and rural arts program is to encourage 4-H Club members to lead a balanced life of play, work and rest; to make friends by participating in groups which enjoy recreation and rural craft arts; to learn to lead and follow recreation activities; to make 4-H Club membership more attractive and self-satisfying, and to promote better health.

Some outstanding activities carried out by club members in winning counties include recreation leadership training meetings, 4-H May Day programs, talent shows, hikes, softball and baseball games, folk dance festivals and parties.

Twenty-seven community 4-H Clubs received blue ribbon awards for recreation activities in 1948.

Lost Dog Found In Garden After Three Years Absence

From The Baird Star — A little spotted dog belonging to A. H. Conlee disappeared about three years ago. Conlee inquired here and there and finding no trace of the dog, decided he must have been stolen or met with a fatal accident.

Tuesday, while working in his garden, Mr. Conlee uncovered a small grave where the dog had been buried only a few days ago. Where had the dog been these three years? Why should anyone bring the dog back and bury him in the garden? Mr. Conlee is mystified and would like to know what did happen to his little spotted dog.

Putnam Receives .82 Inches Rain

Putnam received another good rain the past week. John D. Isenhower reports that the gauge showed a reading of .82 inches. However, it fell so slow that no water was caught in lakes. But the rain will be of great benefit to farmers and ranchers as since the rain and ice the ground had frozen and thawed pushing the ground up and grain and grass was not doing much good as it needed more rain to settle the top of the ground.

Sears Employees Purchase Stock

According to reports, the Sears Roebuck Company make their employees stockholders in the company. The report discloses that 54 employees of the local store in Abilene own stock. The plan was begun several years ago, and each individual was given a statement showing the extent to which each had shared in the company's 1948 profits by way of their membership in the savings and profits.

Mr. McGaughey, the manager, explained that ideal employee group has its credit in the fund an aggregate 1731 shares of Stock plus a cash balance of \$44,261.73. Based on January 31 market value of \$38.00 per share for Sears stock the group has an investment worth \$110,225.58.

Under the pension plan, employees members deposit 5% of their salaries into their individual accounts each year, with the maximum deposit limited to \$250.00 annually. Sears places in the fund an established amount of its profits. The amount is credited to the employee member on a length of service basis. The fund now owns 19 per cent of Sears stock and this ownership makes it the company's largest single stockholder.

Mrs. W. S. Joba was visiting with Mr. and Mrs. M. B. Sprawls and with her grand son in Fort Worth over the weekend.

Improvements Made By Sutphen Motor Co.

Sutphen Motor Company has been making improvements in the front of their show room and parts building. They have been overhauling the entire front by making changes and repainting and decorating, which gives the show room a nice appearance from the front. Also put in was a petition between the mechanical department and the show room that prevents dust and smoke from entering the show room. Two new Dodge cars were being shown Saturday. The new show room puts on a city appearance.

Commissioners Authorized To Issue Warrants

The Attorney General of Texas has given an opinion to the Commissioner's court of Coke county that they had a right to issue \$67,000 in county warrant in order to erect a hospital. District Attorney James Logan of San Angelo requested the opinion. He said that Coke county voters approved of \$50,000 in time warrants for the hospital. However when this was submitted for construction the lowest bid was \$67,000.

The question is, in this case, does the constitution of the state either authorize the commissioner's court to issue warrants against the credit of the tax paying citizens creating a debt for this purpose?

Wednesday Club Entertained By Mrs. W. L. Ivey

Mrs. W. L. Ivey entertained the Wednesday Club in the home of Mrs. Stubblefield, co-hostess. Nineteen members were present.

Club counselor, Mrs. Clyde White, announced that March 7 was Friendship day. Mrs. Brightwell reported that she had received a letter of appreciation from a family in Greece thanking the Wednesday Club for the boxes of clothes sent to them.

The club also voted to donate to the Virginia Brightwell Music Fund, which was named in honor of one of their federation club officers, Mrs. W. P. Brightwell; the Latin-American Scholarship Fund; The Fisk Loan Fund; and the Pennv Music. Mrs. Ivey reported that the Wednesday Club had given 50 books to the Callahan County library through money donations. Mrs. Ivey announced that more money was needed to raise Baird's quota for the Polio drive.

BANK BY MAIL Let Your 1ST NATL

SAVE TIME Bookkeeper Mbr. F. D. I. C

Save 20 per cent on Appliance Loan Borrow From Your Bank 1ST NATL in Cisco—Mbr. F. D. I. C.

BANK CHECKS ARE BEST Keepin' A Rest! Also In Budget Keeping 1ST NATL in Cisco—Mbr. F. D. I. C.

FIRE and THEFT PROTECTION 1c Per Day For Safety Deposit Box 1ST NATL in Cisco—Mbr. F. D. I. C.

BUILD UP YOUR CREDIT 1c Per Day For Savings Bank 1ST NATL in Cisco—Mbr. F. D. I. C.

THE PUTNAM NEWS

J. S. YEAGER, Editor and Manager
 ANDREW WEATHERBY Mechanical Superintendent
 Entered at the Post Office at
 Putnam, Callahan County, Texas
 Second Class Mail Matter.
 PUBLISHED EVERY FRIDAY

Any erroneous reflection upon the character, standing or reputation of any person, firm or corporation that may appear in the columns of The Putnam News will be gladly and fully corrected if brought to the attention of the editor.

Presbyterians To Hold Pre-Easter Services In April

At a joint meeting of the Session and Diaconate Friday night it was decided that a series of Pre-Easter Services will be held April 11-17 at the First Presbyterian Church here. The group voted to invite the Rev. J. Stuart Pearce, a former pastor of the local church, to be the speaker for the services.

Dr. Pearce served the church from 1932 to 1936 and is widely known in Presbyterian circles.

L. L. BLACKBURN

ATTORNEY-AT-LAW
 BAIRD, TEXAS

He was instrumental in the Presbyterians acquiring their camp at Lake Cisco. After resigning the local pastorate, he was home mission superintendent for the Fort Worth Presbytery with headquarters in Cisco. At present Dr. Pearce is retired, but is serving the Community Church of Catarina, Texas.

Former Area Woman Dies In San Antonio

Word was received in Cisco Saturday of the death of Mrs. Sarah Ellen White, who passed away in a San Antonio hospital on February 20. Mrs. White and her husband lived for several years on their farm in the Corinth community. A daughter, Mrs. Lillie Walker, lives between Cisco and Carbon. A son, E. M. White lived in Cisco and was an employee of the Cisco and North Eastern Railway Company while it was in operation.

Mrs. White had lived in San Antonio for a number of years

CHAPIN GIVES PRESS INTERVIEW



Selden Chapin, seated, wearing glasses, American Minister whose recall was demanded by Hungary, gives Press interview

troubled" at public reaction on board the SS Queen Mary. Chapin declared the Hungarian government seems "annoyed and within that country to the trial of Cardinal Mindszenty.—ACME

and the funeral was held there Tuesday. She is survived by six sons and three daughters. The sons are C. H. and O. T. White of San Antonio, E. J. White of Houston, C. W. White of Kingsville, J. W. White of Princeton, Florida and E. M. White of Tynan, Texas. The daughters are Mrs. Lois Lea of Overton, Miss Jewell White of

San Antonio and Mrs. Lillie Walker of near Cisco.

Also surviving are one sister, 21 grandchildren and 14 great grandchildren.

Clinical Society Plans Conference

The Dallas Southern Clinical Society will hold its annual spring clinical conference in Dallas March 14-17 with headquarters at the Hotel Adolphus and the Baker Hotel. Dr. H. Walton Cochran of Dallas, president of the society, announced that guest speakers will be presented in general assemblies, afternoon clinics, round table

luncheon discussions, afternoon and evening symposiums, and a clinical pathologic conference.

The purpose of these annual postgraduate meetings, Dr. Cochran said, is to make available to the medical profession of the South the most modern developments in the various fields of medicine in a constant effort to improve medical care.

Bill Lee was in town Saturday and stated he was employed by Slim Taylor, but as soon as the job was finished, he would return to Big Lake, where he would move his family, where he though he would make his future home.

REFRIGERATION REPAIRS

And Repairs on All Kinds of Electrical Appliances
 Also Rural Wiring

PARSONS ELECTRIC AND REFRIGERATION SERVICE
 Baird, Texas

OFFERS HER EAR FOR SALE



Mrs. Cock Van Gent, 24, Dutch artist, has offered to sell one of her ears for \$24,000 because she needs the money to continue her painting. "I won't compromise," she said, for she refuses to earn her living as a commercial artist or

portrait painter. Mrs. Van Gent rolls a cigarette to save expenses. She is apparently following a pattern of another Dutch artist, the famous Vincent Van Gogh, who painted some of his best art after cutting off one of his ears in a fit of rage.—ACME

YOU GET BETTER-LOOKING SHAVES AT A SAVING With—



HERE! NOW!

AQUELLA

Stops water leakage in basement, foundation, walls, buildings. Aquella fills every tiny masonry pore and expands, making a watertight seal as it sets. Beautiful white, eggshell-like finish continues to harden with age. Will not powder, rub off, blister, peel or flake. Use Aquella for interiors; Aquella No. 2 for exteriors.

\$3.95 Per Gal.
 Covers 40 to 70 sq. ft.



Cisco Lumber & Supply Company
 "We're Home Folks"
 CISCO, TEXAS

WYLIE FUNERAL HOME

Phone 38
 Putnam, Texas

AMBULANCE SERVICE
 Wylie Burial Association
 W. O. Wylie Jr., Sec.-Treas.

Paint--Paint

Something New — Kem Glo

The Miracle Finish For Kitchens
 Bathrooms and the Finest
 Woodwork

LOOKS AND WASHES LIKE BAKED ENAMEL

Call and Inquire About This Paint

F. P. Shackelford
 PUTNAM, TEXAS

IS AN ARMISTICE



The map shows the areas affected by the Rhodes armistice between Israel and Egypt. Agreement gave Israel 25 Jewish settlements in the Negeb (1) captured last October. Egypt won control of a 5-mile strip of Southern Palestine coast (2) from Gaza to Rafa. Each side will be allowed to keep only "defensive forces" in the areas gained. Encircled Egyptian forces at Faluja (3) will be allowed to leave. El Auja (4) will be

seat of a seven-man United Nations demilitarized and become the armistice commission. Egyptian "striking forces" in the Bethlehem-Hebron area (5) will be withdrawn. Israeli "striking forces" in Bir Asluj (4) and El Auja (5) will be withdrawn to points where they began Negeb offensive last October 14. Status of Israeli-held Beersheba (6) will be decided in negotiations with Trans-Jordan. —ACME.

Coach Jack Everett Faces Stiff Task In Grouping Athletic Department; New Set - Up To Benefit 1400 Students

By JIM EWELL, JR.

For the first time since the turn of the decade, city schools will be phitting into effect immediately, a blanketing, utterly new athletic program—designed not to by - pass one of the 1,400 students now attending Cisco schools.

To head this giant - sized undertaking will be Coach Jack Everett, a 39 - year - old Marine veteran who could not have faced a more complexing task in the Jap infested jungles of the South Pacific. To Everett, the job will be as big at that.

Jack Everett, who acquired the nickname "Iron - Jaw Everett" after his first year at CJC, spent three years at Rice Institute before enlisting in the Marine Corps in 1942. During the South Pacific campaign, Everett was attached to the Fourth Marine Division. He received his disharge in 1945.

After the Jap capitulation, Everett returned to Rice Insti-

tute and one year later completed studies for a B. A. Degree.

A major in physical education, he embarked upon his first job in that capacity, and upon graduation he was named to be an assistant in the Rice athletic department.

Everett, who was born near Putnam on July 16, 1919, was asked by Cisco school officials, the following summer, to form and train a football team at Cisco Junior College, the first for many years. With certain knowledge that the new job would be difficult, Everett mapped out his strategy and set operations to work.

In the few short months that he had left to group and mold a team, then set out to make the college a name, Everett did accomplish the job. In 1947, a real fighting machine of husky and aggressive football players came thundering down from the

hill top college, setting the grid-irons ablaze with wins.

With a second successful year to the background, those same school officials approached Everett with the proposition of heading the entire city school system as athletic director, and coaching the high school football team.

"Such a job has been a life time dream," Everett said in an interview Friday. "Physical education has always been my dish, and with proper support, this new program will be a benefit to our schools."

At the present, Everett is preparing to shape a track squad at high school as the first of a series of athletic undertakings. About 20 boys were expected for training at his summons next week.

Track equipment has already been secured by the school, and portions of it has been distributed to the tracksters. Tennis, softball, soccer and volleyball will be included in the new set-up Everett said.

Meanwhile the board elect Assistant Coach Stormy Davis to assume head coaching duties of the junior college. It was reported that the new head mentor had called for the beginning of spring training sometime this week. Some 40 aspirants will answer the call.

Mr. and Mrs. George Weeks of Merkei were down Sunday visiting with Mrs. Lejia Carr.

Burton-Lingo Lumber Co.

Cisco, Texas

THE BEST PLACE TO BUY YOUR BUILDING SUPPLIES
WE CAN FILL YOUR NEEDS FOR MOST ANY KIND
OF LUMBER, SHINGLES and OTHER
ROOFING MATERIAL.

SEE US FOR
House Paint and Wall Paper
Big Stock of Each

GIVE US A RING WHEN IN NEED OF ANYTHING

RAY'S GARAGE

BAIRD, TEXAS

When your old jallopy is giving you trouble look up or call RAY'S GARAGE In Baird. See how quick we can get the job done. First Class Mechanics.

OLDEST CHEVROLET DEALERS IN THE COUNTY

Good stock of Chevrolet parts at all times. Give us a ring when you have troubles.



FORWARD, MARCH!



• March is here again, the month that heralds spring—and spring housecleaning!

• In Grandma's day, housecleaning—and housekeeping, too—meant endless rounds of back-breaking drudgery. But today, thousands of wise West Texas homemakers call on their low-cost electric servant, Reddy Kilowatt, to help take the work out of housework—to cook and clean, wash and iron, sweep and sew.

• For less than you'd pay for a daily pack of cigarettes, electric service makes life easier, healthier, more comfortable. What other item in your family budget gives you such great living value—at such little cost?

West Texas Utilities Company



Arthritis Pain

For quick, delightfully comforting help for aches and pains of Rheumatism, Arthritis, Neuritis, Lumbago, Sciatica, or Neuralgia try Romind. Works through the blood. First dose usually starts alleviating pain so you can work, enjoy life and sleep more comfortably. Get Romind at druggist today. Quick, complete satisfaction or money back guaranteed.

FOUND!

LOW COST TRACTOR PUMP FOR HIGH PRESSURE JOBS

Even Flo

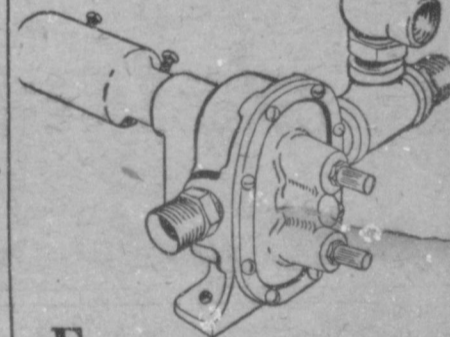

Even Flo is a real find—pumps 500 gallons per hour—builds up pressure to over 100 pounds operating on low throttle. Fully guaranteed, this dependable pump is easily attached to the power take-off of any tractor—instantly ready for fighting fire or spraying. Even Flo's cast bronze case and yellow brass gears assure long, useful life. Accept no substitute—when you buy Even Flo you buy the best. Ask your dealer for a demonstration today.



S. P. Shackelford
PUTNAM, TEXAS

Insurance, Bonds and Financing

Complete Abstracts to ad land and town lots in Callahan Co.

Callahan Abstract Company

MARION VESTAL, Manager.
RAYMOND YOUNG, Owner.

Personals

Mr. and Mrs. E. E. Sunderman spending the weekend visiting with their son at Dahlhart, who has been ill for the past few days.

Mrs. George Baker, or Eunice, New Mexico, was here the past weekend visiting in the home of her parents, Mr. and Mrs. M. H. Cook, Sr.

Mrs. Leola Coleman, a sister of Mrs. Coleman, was here from San Francisco the past week-end visiting in the home of Mr. and Mrs. Joe Coleman.

Mr. and Mrs. M. M. Little were shopping and looking after business interest in Cisco Saturday afternoon.

Miss Ora Clinton was in Putnam a few days ago and left another year's subscription

to the Putnam News. Thanks, Miss Ora.

Dr. R. D. Brown of San Antonio called Mrs. Pierce Shackelford Saturday and told her that he and Mrs. Brown were the parents of a baby boy weighing eight pounds mother and baby doing nicely.

Ace Hickman, a prominent rancher in Baird, set his subscription dates up another year, Saturday. In talking of the ice and rain, Mr. Hickman thought it was a fine thing and would make a lot of early grass and beside, put a good season in the ground for farming.

Mr. and Mrs. Benton Brown are the parents of a baby son born in the Callahan county hospital at Baird Saturday morning. The youngster weighed 9 pounds, 3 ounces. Mother and baby are both doing nicely.

Health officer Cox reports that there are 3,000 cases of measles in Texas at the present time.

Remember the Methodist meeting will start Sunday with the Rev. Stephens of Cisco, pastor of the Methodist church will assist the Rev. Swim in

holding the meeting. Everybody is invited to attend these services. Preaching morning and evening.

Mrs. Mona Cook returned from Midland Saturday where she had been visiting her son and family, Mr. and Mrs. F. Y. Cook.

Mr. and Mrs. Shields Heyser of Wichita Falls have been visiting Mr. Heyser's mother, Mrs. J. A. Heyser and brother, Fred and wife.

Raymond Caldwell, of Fort Worth was a guest of Mr. and Mrs. George Biggerstaff last week. Raymond is the son of the late Dr. H. V. Caldwell, who had a leather shop in the Texas Hotel in Fort Worth. His mother, after the death of the doctor sold her home in Breckenridge and purchased another in Fort Worth. Her son, Billy, lives in San Angelo. The Caldwells formerly lived in Putnam.

Mr. and Mrs. W. L. Yeager of the Bluff Branch Community were visiting with Mr. and Mrs. J. S. Yeager Sunday.

Emanuel Wilcoxon was in from the Cottonwood community last Thursday afternoon. He reported

about an inch of rain. The ground was thoroughly seeded and he thought we had the best season in the ground in a number of years.

M. H. Cook, Sr., was in Dallas the past week end visiting with relatives and looking after business interests, returning to Putnam the first of the week.

Mrs. Pete King spent the week end visiting with her sons, James King and family and Edward in Fort Worth. Mrs. King stated her son Edward was to sing in an opera Saturday night. Jack Miller has been on the sick list for the past several days.

Miss Ora Clinton of the Scranton community is spending a few days visiting with his sister, Mrs. E. C. Waddell, this week.

Mrs. Maggie Woods of Memphis, Tenn., is here visiting in the home of Mrs. S. W. Jobe and relatives and friends in the Scranton community.

New Businesses Given Charters

AUSTIN, Feb. 26. — Texas charters were granted 286 businesses with a capitalization of \$7,908,000.00 in January 1949,

total was 398.

Merchandising establishments received 81 charters; real estate, 42; manufacturing, 32; and construction, 22.

42 Tournament To Be Held At Legion Building

Mrs. H. N. Lyle, president of the American Legion Auxiliary, announced today that a "42" tournament will be held at the Legion Hall Thursday afternoon and night.

The afternoon play was scheduled to begin at 3 o'clock and the evening play will follow at 7:30 o'clock. A 25 cent admission charge was set at the last meeting.

The proceeds of the tourney will go into the building fund for the purpose of adding to the interior decorations. All Cisco and surrounding area were invited to enter the play and to visit the hall during the tourney.

BACKACHE

For quick comforting help for Backache, Rheumatic Pains, Getting Up Nights, strong cloudy urine, irritating passages, Leg Pains, circles under eyes, and swollen ankles, due to non-organic and non-systemic Kidney and Bladder troubles, try Cystex, Quick, complete satisfaction or money back guaranteed. Ask your druggist for Cystex today.

Make Our Grocery Your HEADQUARTERS

Best Grade of Sliced Bacon

A Good Stock of Staple and Fancy Groceries

To Select From

Try Us For A Good Roast

We Solicit Your Continued Patronage and

Will Serve You With Quality Goods

We Buy More and Can Sell For Less!

Why Not Give Us A Trial With Your Next Order?

ODOM'S CASH GROCERY

LIFE IN THE ROAR by KANE

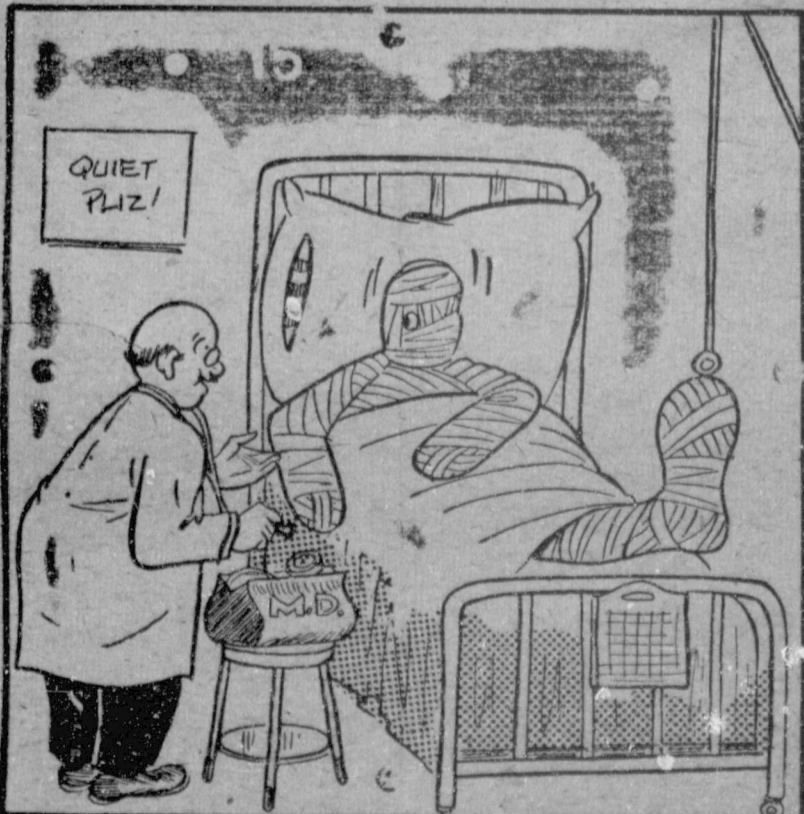

"YOU'LL BE OUT IN A WEEK - YOU'RE BEGINNING TO LOOK MUCH BETTER ALREADY."

A TOAST TO THE QUEEN



King Mid-City, one of the carnival season's many monarchs, pauses during his triumphant tour of New Orleans to toast his queen and her maids. Overflowing crowds filled all the streets during the Sunday parades. — ACME.

ONLY FIRE - BLACKENED HULK LEFT

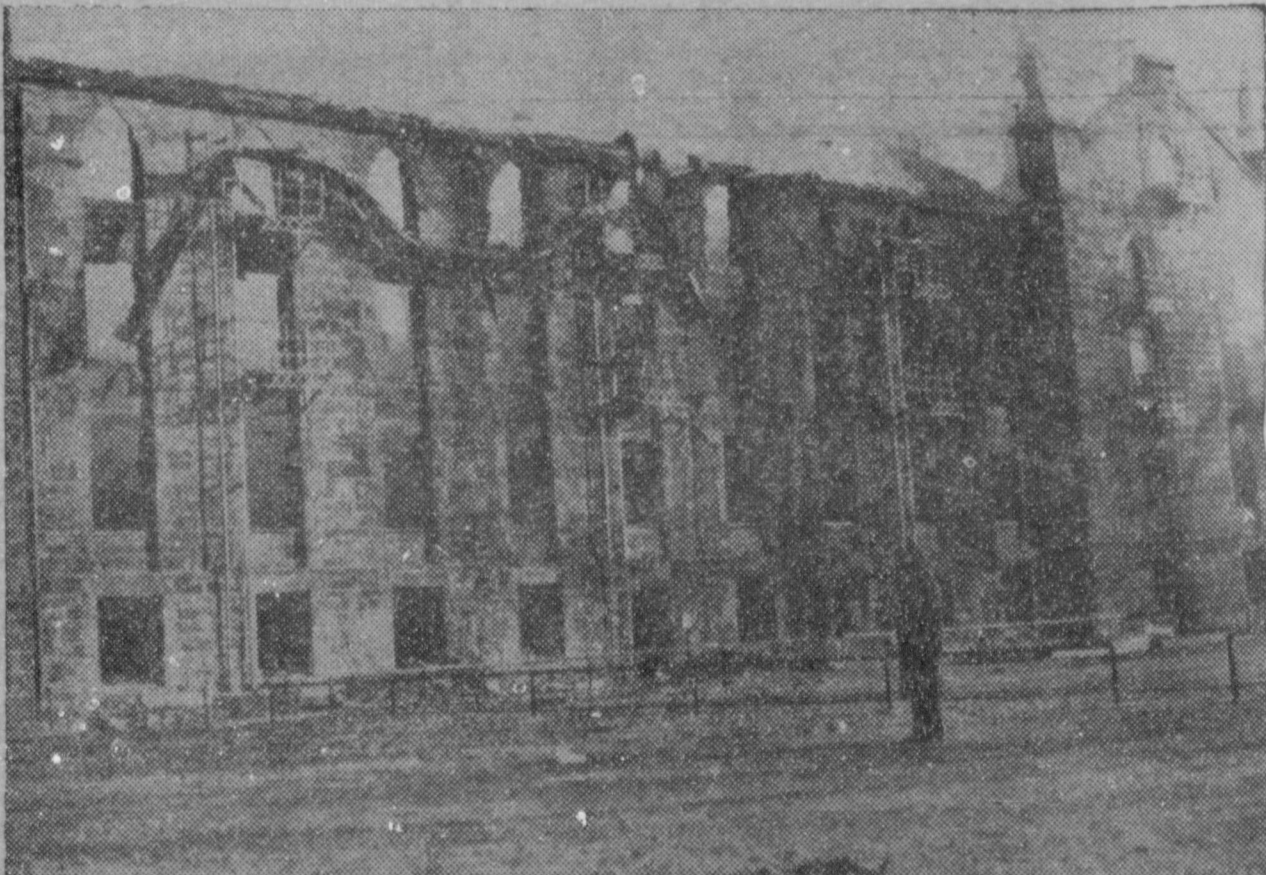

A fire-blackened hulk is all that is left of "Old Kenyon Hall," which originally housed the college in earlier days at Gambier, Ohio. The building, which housed two fraternities and independent and a student group was 122 years old. Fire escapes near the windows aided many students in their flight to safety when the building burned early Sunday morning. — ACME.

IS A MAIL DEER

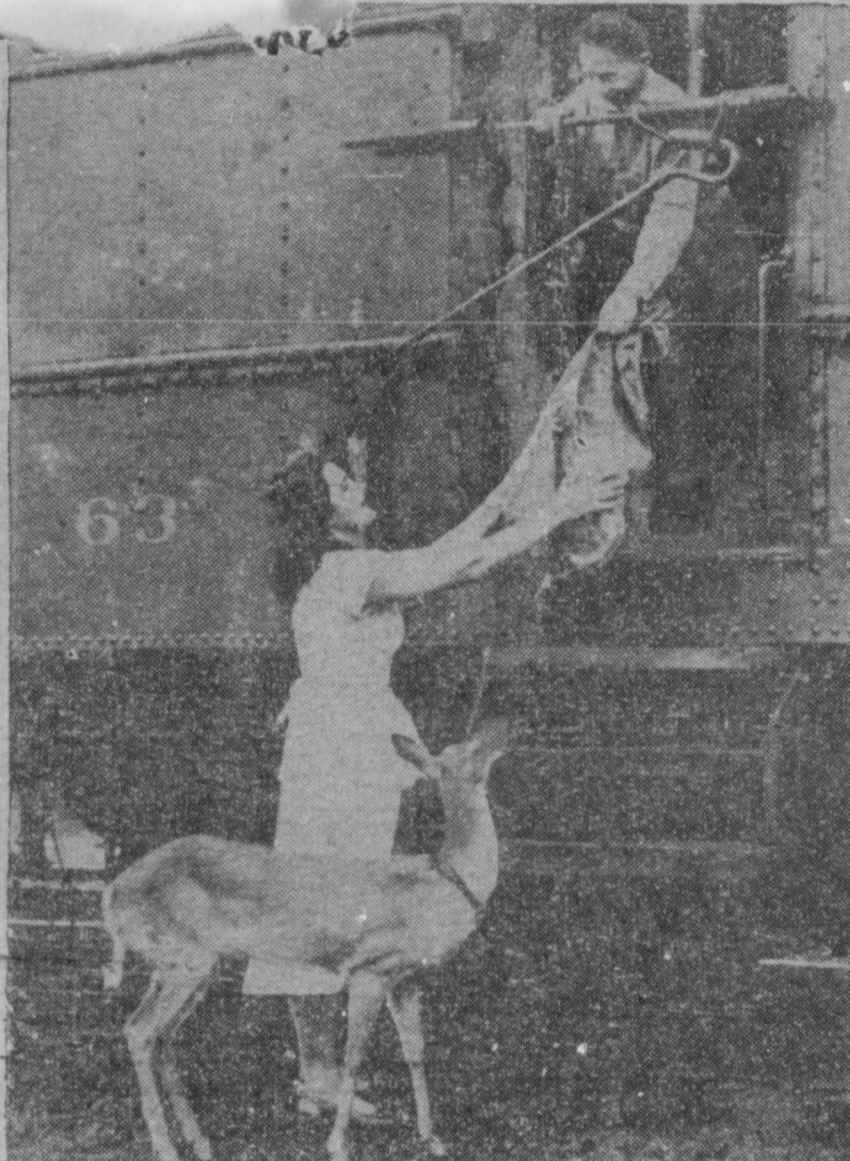

In Council, Ga., everybody knows Flagg, the 2-year-old pet doe belonging to Postmistress Mrs. Rose Johnson. Flagg scampers with Mrs. Johnson on her daily rounds. Here, the deer watches while railway postal clerk B. H. Talley gives Mrs. Johnson the mail delivery. Then, they'll go to the post office, stopping off at stores where Flagg usually gets some candy or soft drinks. — ACME.

The Church of Christ



A false balance is an abomination to the Lord; but a just weight is his delight. The in-

tegrity of the upright shall guide them but the perverseness of transgressors shall destroy them — Proverbs 11:1-3.

Wealth gotten by vanity shall be diminished; but he that gathereth by labor shall increase. — Proverbs 13:11.

Love not sleep, lest thou come to poverty; open thine eyes, and thou shall be satisfied with bread. — Proverbs 13:11.

Recompense to no man evil for evil. Provide things honest in the sight of all men. — Romans. 12:17.

Let him that stole steal no more; but rather let him la-

bor, working with his hands the thing which is good, that he may have to give to him that needeth. — Ephesians 4:28.

The Lord commends the man who is willing to work and earn his wage. Not only is this a command in principal but loyal and faithful service done well is a reward in itself and makes daily bread sweeter. Let us work and serve others as we would desire of them.

By Carl C. Collier

New Brake Bonding Method Adopted

DETROIT, Feb. 26. — A new method of bonding the brake lining to the brake shoe that has already proved itself in more than 3,000,000 brake assemblies has been announced by W. F. Armstrong, general manager of the Chevrolet Motor Division.

The statement included the disclosure that the development already has been installed on 1949 passenger cars. Chevrolet is the first major manufacturer to adopt for its full passenger line a type of brake construction that has been the object of laboratory research for several years.

Health Officer Would Prevent Spread of Disease

AUSTIN, TEXAS, Feb. 27 — In a vigorous campaign to elevate the State health level by preventing the spread of communicable diseases which might be transmitted by foods, the State Department of Health is conducting training schools for food handlers in all sections of Texas, according to Dr. George W. Cox, State Health Officer.

"Food handlers are being instructed in sanitary methods of repairing, handling, and serving food for public consumption," Dr. Cox said. "Actual experience has shown that an insanitary eating establishment is one of the surest sources of spreading infection. The lack of proper sanitation in food handling is a definite menace to public health and our goal is the education of cooks, waiters, butchers, bakers,

BURIES DAUGHTER ALIVE



Charles E. Holober, left, 39-year-old jewelry clerk who admitted shooting his wife and burying their 8-month-old daughter alive in a shallow common grave near Fairfax, Virginia, displays an unconcerned grin as he stands with Detective Sergeant Harold Huffman at Washington, D. C., police headquarters. The murders were committed Thursday and the bodies were found Sunday. — ACME.

fountain men, and all other food handlers to such a level as will insure an elimination of this health hazard."

The training schools consist of elementary courses in bacteriology, communicable diseases, diseases, medical zoology, foods, tation, sterilization, personal hygiene and sanitation.

Since the program was instituted about 8 years ago, more than 400 schools have been conducted, with a total of over 25,000 food handlers receiving their certificates of completion in the courses.

Arrangements for such a food school can be made through any county health unit, by requesting the service from the Division

of Health Education, State Department of Health, Austin, Texas.

HIGHEST CASH PRICES PAID for DEAD or CRIPPLED STOCK



CENTRAL HIDE & RENDERING CO.

For Immediate Service Phone

4001 Collect Abilene, Texas

R. E. Grantham ATTORNEY-AT-LAW Practice in all Courts CISCO, TEXAS

ASTHMA

Don't let coughing, wheezing, recurring attacks of Bronchial Asthma ruin sleep and energy without trying MENDACO, which works thru the blood to reach bronchial tubes and lungs. Usually helps nature quickly remove thick, sticky mucus. Thus alleviates coughing and aids freer breathing and better sleep. Get MENDACO from druggist. Satisfaction or money back guaranteed.

Future Farmer Fabricates New-Design Quonset



Max A. Cobble, 19, Future Farmers of America national student secretary, welds one of the first arch-rib sections turned out for the new-design Quonset buildings. The Midway, Tenn., farm youth leader tried his hand at the big multiple welding machine during FFA national officers' visit at the Ecorse, Mich., plant where Quonsets are made. The building's new design features faster erection with lower completed-building cost, stronger structure and streamlined appearance seen in this photo. Lower inset shows workmen installing new-type bridging, the ladder-like supports between the steel building's ribs.

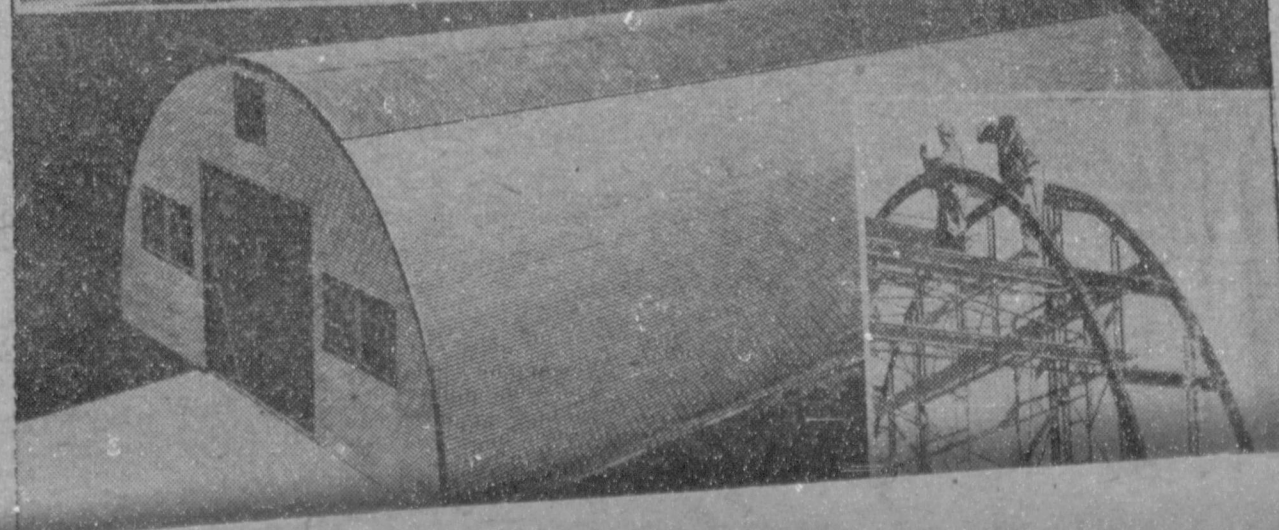

ANNOUNCING

The Abilene Reporter-News

Early Spring Short-Term

Special Mail Rate

7 FULL MONTHS 5.95

Morning & Sunday

By Mail In West Texas

REGULAR RATE IS \$1.25 A MONTH

SUBSCRIBER SAVES \$2.80

STEPHEN DOESN'T KNOW



Stephen Gordan, 2½, arrives in Seattle, Wash., after a boat trip to Japan. He knows that he's going to visit his grandmother, Mrs. Carrie Stephens, in Spokane, Wash. He doesn't know he's now an orphan. He doesn't know that the ship also carried the bodies of his mother and father, M-Sgt. and Mrs. James Gordan, who were killed in a jeep-train accident in Japan. Army nurse Lt. Catherine O'Connor, right, brought Stephen back to the U. S. — ACME.

FLYING CROSS FOR SERGEANT



Army Chief of Staff General Omar Bradley awards the Distinguished Flying Cross to Sgt. Robert L. Hodgkiss for heroism in a recent plane crash. Hodgkiss supervised the jumping of 36 paratroopers in the stricken plane, riding out the crash himself, and then helped to rescue injured crew members when the plane started to burn. L-R: Mrs. Edward Taylor, Mt. Pleasant, Ohio, his mother; General Bradley; Sgt. Hodgkiss, and Mrs. Pearl Hodgkiss, his wife. — ACME.

Here's one of the greatest iron tonics you can buy to

**BUILD UP RED BLOOD
to GET MORE STRENGTH**

if you have
SIMPLE ANEMIA

You girls and women who suffer from simple anemia that you're pale, weak, 'dragged out'—did you ever stop to think this condition may be due to lack of blood-iron? Then do try Lydia E. Pinkham's TABLETS.

Pinkham's Tablets are one of the very best home ways to help build up red blood to get more strength and energy—in such cases. Without a doubt they are one of the greatest blood-iron tonics you can buy today. See if you, too, don't remarkably benefit!

Pinkham's Tablets are also a very pleasant stomachic tonic! All drugstores.



MONTHLY FEMALE PAINS
Pinkham's Tablets are also very effective to relieve monthly cramps, headache, backache—when due to female functional monthly disturbances.

Lydia E. Pinkham's TABLETS

Eastland County Is Allowed 47,000 Acres Of Peanuts For 1949 Season

— Eastland County peanut growers may plant 47,000 acres of the crop during the coming season without penalty under the government's allotment program, AAA Administrator Emmet Powell said last week. The allowable was much greater than was at first anticipated and only 7,000 acre under the all time high of 54,000 acres. The farmers were pleased that the cut was as

small as it was and were accepting it in good grace, Powell said.

The cut of approximately 22 per cent can be made up by a lack for the past two years good crop season that has been he said. The farmer can actually realize more money from the smaller acreage if the elements are kinder than they were during 1947 and 1948.

Powell said that it would not be known until July what the government support price on the 1949 crop would be.

There have been some individual complaints about the acreage allotments for the county, Powell said, but all complaints have been met by adjusting errors that have crept into the allotment program.

Acreage taken out of peanuts by the control program will be planted largely to grain sorghums or turned to pasture, Powell

believes on the basis of remarks made by the farmers.

Rural Roads Bill Set For Hearing On March 7

A bill of great importance to every Texas citizen will come before the Revenue and Taxation Committee for a hearing on Monday at 7:30 p. m., according to a county spokesman. The bill, HB - 59, was designed to raise a sufficient amount of money to be used by the counties each year in the building of good rural roads.

The bill is vigorously sponsored by the County Judges and County Commissioners Association, Texas Rural Roads Association, Farm Bureau and Rural Letter Carriers Association of Texas.

Eastland County citizens were asked to attend the meeting or to write the representatives and State Senators requesting their help in passing the bill.

Fiery, Itching Toes and Feet

When feet burn, sting, itch and shoes feel as if they were cutting right into the flesh, get a small bottle of Moone's Emerald Oil and rub well on feet and ankles morning and night for a few days.

A real discovery for thousands who have found blessed relief. Moone's Emerald Oil is easy and pleasant to use—stainless—money back if not satisfied—good druggists everywhere.

Follow Your Doctor

● Many leading physicians turn naturally to this Professional Pharmacy for their office requirements. Often, too, they suggest that patients bring prescriptions here for careful compounding. Follow your Doctor's example. Bring his next prescription right to us.



Modern Physician

● Your Doctor is the one to whom you naturally turn for care and counsel in matters relating to the health of your household. Ask him about this Professional Pharmacy. And, on his recommendation, bring prescriptions to us for careful, precise compounding at reasonable prices.



Lemore Pharmacy
Cisco, Texas

SEE NANCE MOTOR CO.

"Your Friendly Ford Dealer"

For - Used Car Bargains - Genuine Ford Parts - Dependable Mechanical Work - 24 Hour Wrecker Service

Phone 244

24 Hour Wrecker Service

Phone 836M

FRIENDLY CHAT AT DINNER



President Truman huddles for a chat with Senator Scott Lucas, Democrat from Illinois, during the Jefferson - Jackson Victory Dinner in Washington. Mr. Truman reminded the celebrating Democrats that at last year's dinner he told them they were looking at the next President; "and you are" he said. Three thousand attended the \$100-a-plate banquet, so huge it had to be held in two Washington hotels. — ACME.

GIANT WAVES POUND BEACHES

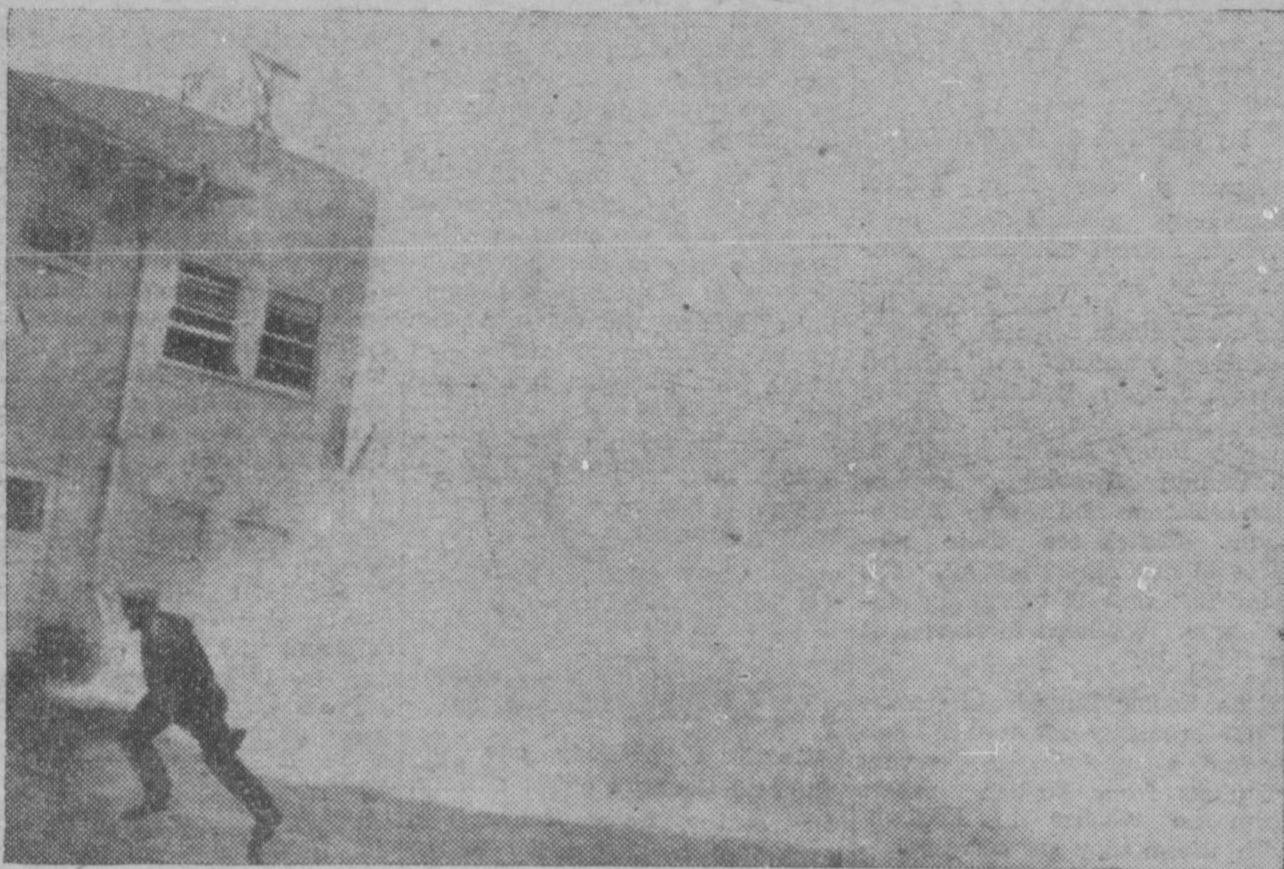

Giant waves which pounded the Redondo Beach area near Los Angeles, Calif., nearly catches a volunteer worker attempting to salvage possessions from an ocean-flooded residence. — ACME.

Revenue Collection Hike Is Reported

AUSTIN, Feb. 26. — Federal internal revenue collections in Texas totaled \$218,279,230 in January, a rise of 24 per cent over January 1948, the University of Texas Bureau of Business Research reported.

Increases of 34 per cent in the North Texas district and 16 per cent in South Texas were reported.

Collections of- 726,935,016 for

the six months' period of July 1, 1948 - January 31, 1949, as compared to \$632,904,840 for the last six months in 1947 - 1948, represented a 15 - per - cent gain.

Foreign Language Meeting Planned

DENTON, Feb. 26. — Teachers and students of foreign languages in Texas high schools and

junior colleges have been invited to a Field Day at Texas State College for Women March 19.

Modern teaching methods used by the college foreign language department will be exhibited. Department laboratory equipment includes a recording system which makes it possible for each student to hear his progress throughout instruction, and for visitors to hear how students are taught.

PRESCRIPTIONS

Let Us Fill Your Prescriptions.
Filled Promptly And With Care

We Have The Largest Prescription Drug
Stock In Eastland County

Day And Night Service

Call Or Visit Our Store When In Need
Of Anything In This Line

DEAN DRUG CO.

The REXALL Store. Phone 33
CISCO, TEXAS

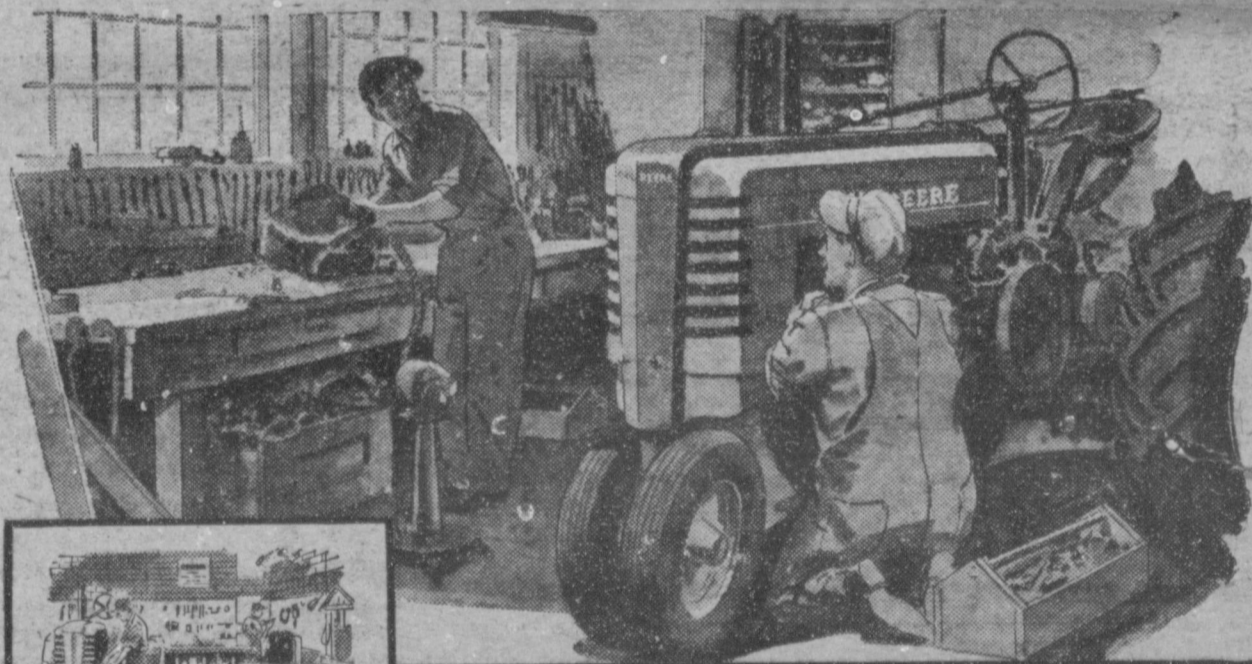

*Ours is the Only Shop in this
Community that offers You
ALL THREE!*

When it comes to reconditioning John Deere Farm Equipment, no other shop in this community can give you the kind of service we offer

In our shop every machine is overhauled the way the factory recommends—thanks to the special training of our skilled mechanics. We've equipped our shop with modern precision equipment, enabling our servicemen to do better work. And, too, only *genuine* John Deere Parts are used as replacements . . . assuring continued better performance.

See us for complete details.

F. P. Shackelford
Putnam, Texas

Cleaning Pressing Altering
Repairing

Ladies' And Men's Suits
Made-To-Measure

FASHION CLEANERS

G. M. Peek
Best Equipped

Putnam School News

By MRS. J. B. SHANNON

Recently our High School Popularity contest was held. Evelyn Ingram and Ross Finley were elected "High School Favorites." The class favorites are as follows: Seniors, Au- Frances Waddell and Richard Aines; Juniors, Ila Mae White and William Donahoo; Sophomores, Patsy Ann Frye and J. R. Bailey; Freshman, Emmettene Tatom and Steve Rosenbaum. Watch for their pictures in our school annual, "The Panther," that is being produced now. We hope to receive it by May 10.

The Senior English Literature Class recently received a letter and a package of current clippings from English papers from the teacher in England with whom they are corresponding. The clippings were sent in appreciation of a love gift sent her by the Seniors and the Women's Club of Putnam. Miss Audry Benton is a music specialist in Pudsey, York's elementary School, and she and

an English teacher in this same school compiled the collection received. Many current facts are revealed in the material, and they are quite characteristic of our own magazine material except in formality.

We are quite proud of this activity as it is the only one of its kind that we know of that is under way in Callahan County. It is carried on through Beta Upsilon Chapter of Delta Kappa Gamma of Cisco of which Mrs. Shannon is a member.

Mrs Fannie Moudy Dies Wednesday ; Funeral Thursday

Mrs. B. F. Moudy, one of Eastland County's oldest citizens, died at the home of her son, Arch Bint, at 12:30 today at the age of 86. She had been a resident of Cisco and the county for most of her life.

She received serious burns Sunday when her clothing became ignited and she has been

near death since that time.

Mrs. Moudy was born in Texas on September 15, 1862 and had been a member of the Methodist Church since her childhood.

Funeral services will be held at the First Baptist Church Thursday at 3 p. m. with Rev. H. R. Blair in charge. He will be assisted by Rev. Otis Strickland. Burial will be in Oakwood with Thomas Funeral Home in charge of the arrangements.

She is survived by one daughter, Mrs. J. W. White of Long Beach, California; one son, Arch Bint of Cisco and a brother, Jim Smith of Borger. Joe Smith, Cleburne; Edgar Smith, Hamilton; three sisters, Mrs. Lena Scott, New Mexico; Mrs. Effie Wright, Reed, Oklahoma, and Mrs. Ollie Dunaway, Cisco.

Also surviving are 17 grandchildren, 32 great grandchildren and one great-great-grandchild. Her grandsons will serve as pallbearers.

A. Z. Myrick Is Re-Elected Dairy Assn. President

electd president of the Eastland County Dairy Association at a meeting held in the Eastland County courthouse Monday

• "Saved my Life"

A God-send for GAS-HEARTBURN!

When excess stomach acid causes painful, suffocating gas, sour stomach and heartburn, doctors usually prescribe the fastest-acting medicines known for symptomatic relief—medicines like those in Bell-Ans. No inactive. Bell-Ans brings comfort in a jiffy or return bottle to us for double money back!

BELL-ANS for Acid Indigestion 25¢

WANT ADS

• For Sale

1948 PLYMOUTH 4 - door Sedan — 8,000 actual miles — Plastic seat covers — Kool Breeze and heater. Wife and husband only drivers. Maxon color. Better than a new one. Eddie Konczak, Baird, Texas,

Plenty of Barb wire in stock now. If in need of wire we can fill your want at once. F. P. Shackelford.

Used Cars — 1929 Ford Sedan 1934 Chev. Coupe, 1935 Chev. 1935 Dodge Sedan, and 1936 Dodge Sedan. W. A. Chrisman, Baird.

BABY CHICKS: Highest Quality, Lowest Prices. Buy chicks from us this season and save the difference. Modern, all electric 140,000 capacity incubators. AAA and AAAA grade chicks. Come to see us or write for a Price List. STAR HATCHERY, Baird, Texas.

SHANKS NURSERIES

Largest Apple Orchard in Texas Clyde, Texas

ONE SIX-ROOM house for sale n Putnam. Six rooms, bath and other conveniences. Modern. Just been overhauled and in good shape. Apply at the NEWS OFFICE for further information.

FOR SALE: Six room house, modern in every respect. 10.5 acres fine truck land, modern sewage, bath, hot water, venetian blinds, garage, barns, chickenhouses, celler, plenty fruit trees, close to churches and school. Located at Olden, Texas. Ideal place for chicken or truck farm. This is a real buy, will move soon. See or call Mrs. E. N. Hull, Olden, Texas or The Putnam News.

FLOWERS for all occasions, free delivery. Flowers wired anywhere. Kelton's Flower Shop, Baird, Tex.

SIGNS OF SPRING



With baseball's spring training season about to swing into high gear, the first group of St. Louis Cardinals report to their St. Petersburg, Florida, camp. Buzzy Wares, center, Card coach, holds a jacket against Red Schoendienst, Redbird second baseman, as clubhouse attendant Butch Yatkeman watches. — ACME.

night, it was announced Tuesday. Also re-elected for another year were Harry Crow of Carbon, vice president, and L. R. Higgenbottom of Gorman, secretary - treasurer.

A nominating committee was appointed to name candidates for the board of directors, who will be elected at the next meeting.

Members heard a report on the organization's artificial insemin-

ation program, and the extension of the program was discussed. The technicians reported that 60 cows had been serviced under the program during the first three weeks of operation.

It was decided to begin a membership drive among dairymen and business men of the county at an early date and plans for the drive were discussed.

Plans for the Eastland County Dairy Show were discussed and it was decided to hold the show in Eastland on April 15. A committee was appointed to work out the details of the show and to prepare a show bulletin and program.

President Myrick reported that the meeting was well attended and that interest was greater than at any previous meeting. He reported that the Association was working on wide plans for the development of a great dairy industry for the county.

Danger Of Wind Damage Decreases

The hazard of wind damage o Texas fields and crops was decreasing daily due to heavy rainfall over much of the state and the rapid growth of grains and grasses, according to a report from the United States Department of Agriculture.

Farmers over a wide area made rapid progress in plowing and bedding land in preparation for spring planting last week, but the work came to an abrupt halt as more rains made field work impossible. During the fair weather that prevailed over most of the state for a few days, substantial progress was made in the seeding of oats and barley acreage.

In the plains area wheat grew rapidly and further diminished the chance of serious wind damage. Corn was planted as far north as central Texas.

Range and pasture responded to warmer weather and supplemental feeding. A fast decline in the number of being grazed by the animals became apparent. The number of animals being grazed by the animals became apparent. The number of animals being grazed by the animals became apparent.



LET BEAUTY GO TO YOUR HEAD

Thrill to a carefree Spring and Summer Fashion perfect Coiffure — so easy to care for — so petty to look at.

For Appointment Phone 9

FOURWAY HAIRCUT REVLON COSMETICS

BROADWAY BEAUTY SHOP

Two Doors West of Palace Theatre Cisco, Texas

USED CARS

AT A

BARGAIN!

Earl Johnson Motor Co.

—Bring Your Ford Back Home—

Sales

Phone 218

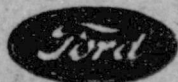

Service

Baird, Texas

A Checking -- Account

Gives All The Answers How Much Did I Pay? For What Did I Pay? Whom Did I Pay? When Did I Pay? What's Left?

Make living in 1949 easier and happier by using this simple systematic method of taking care of your financial obligations with a complete record for references.

You know where you stand every day.

Citizens State Bank

Member of the F.D.I.C.

Cross Plains

Texas